

STC600S

STC600S TRUCK CRANE
60 TONS LIFTING CAPACITY

Quality Changes the World

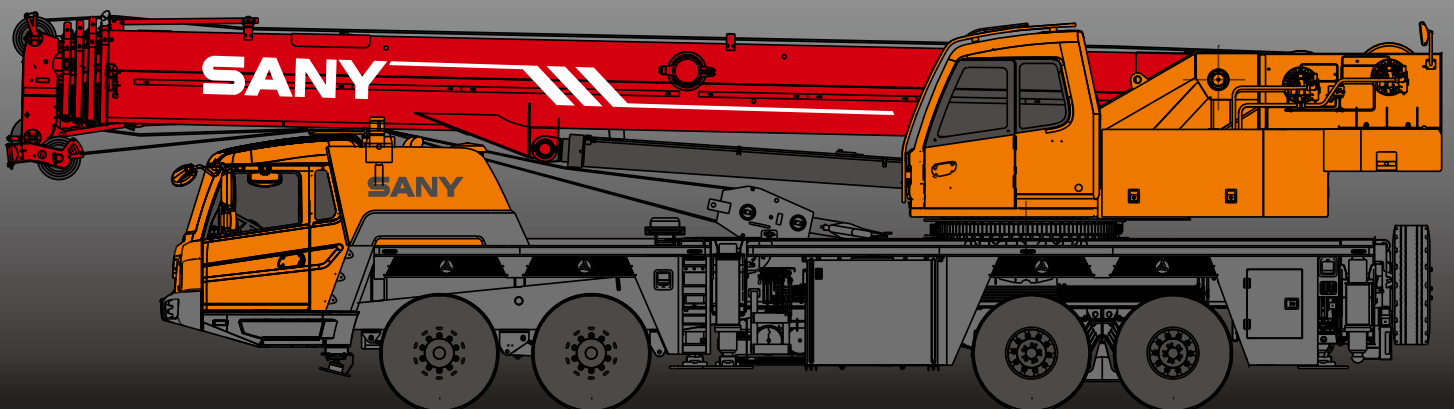

SANY

■ SANY Automobile Hoisting Machinery is one of the core business units of Sany Heavy Industry, mainly engaged in the research and development of high-end, mid-to-large tonnage crane series, including mobile crane, crawler crane, tower crane and loader crane. It has two industrial parks in Ningxiang and Huzhou. Since entering the market, the products of Sany Automobile Hoisting Machinery have received worldwide recognition with advanced technology, lean manufacturing, high reliability and excellent service.



SANY TRUCK CRANE

CONTENT

- 04 Icon
- 05 Selling Points
- 06 Introduction
- 09 Dimension
- 10 Technical Parameter
- 11 Operation Condition
- 12 Load Chart
- 15 Wheel Crane Family Map

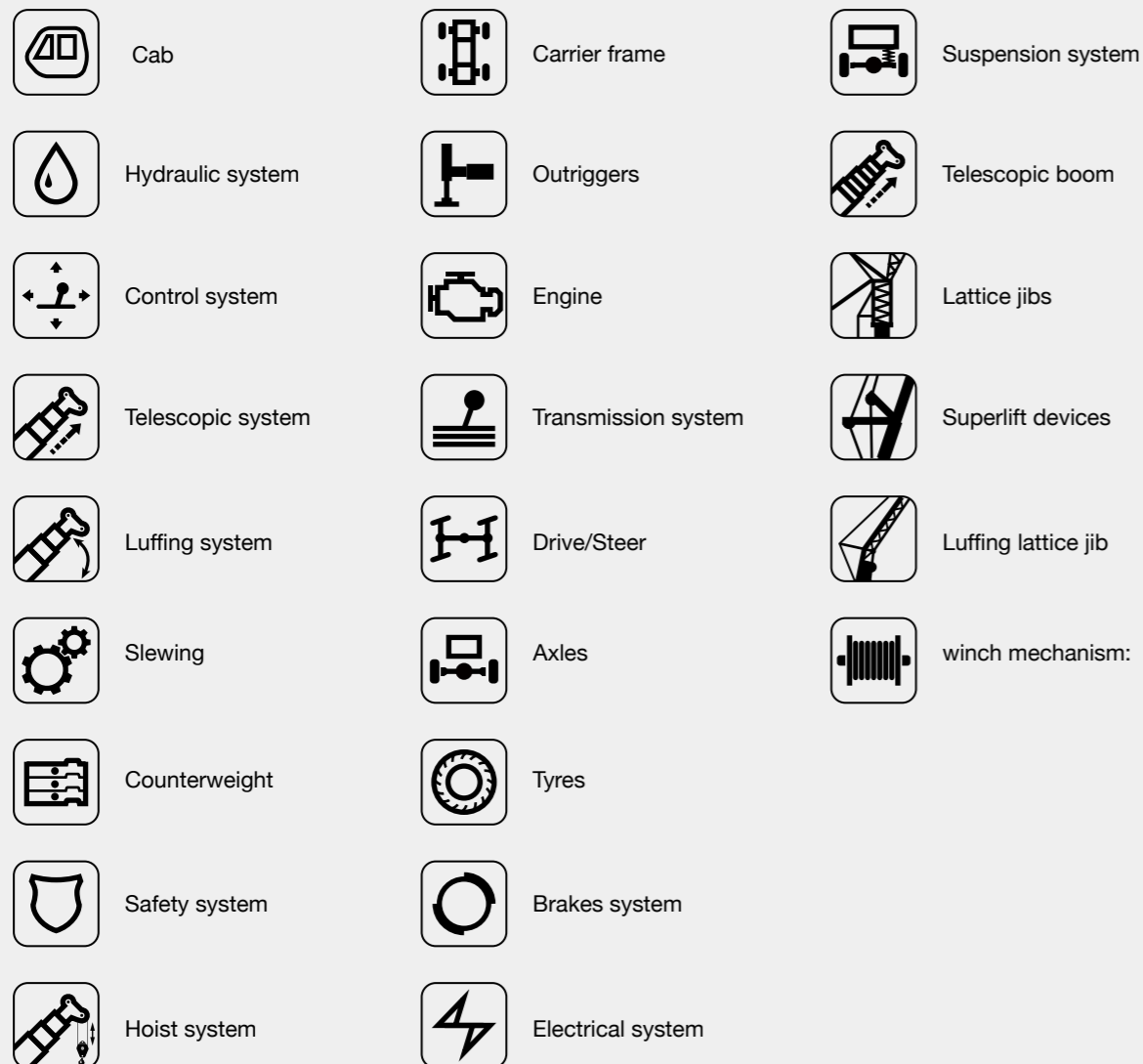

Excellent and stable chassis performance / chassis system

Double-axle drive is used, providing good trafficability and comfortableness under complex road condition with reliable traveling performance. Rubber suspension is applied for rear axle to reduce shock and enhance comfort during travelling. Engine has the multimode power output function, which reduces power consumption. The use of tipping over early-warning technology provides high stability and safety of the overall operation.



Highly efficient, stable, energy-saving, and adjustable electric proportion hydraulic system

Hydraulic system load feedback, constant power control, plunger pump and electric controlled main valve featuring high efficiency, low consumption of energy and good micro-mobility. Unique steering buffer design is adopted to ensure stable braking operation.



Ultra long, super strong and highly sensitive load lifting capacity

Five-section boom of high strength steel structure and optimized U-shaped cross section reduces weight significantly with higher safety rates. Jib mounting angles are 0°, 15°, and 30° which ensures fast and convenient change-over between different operating conditions so as to improving working efficiency of the machine.





Safe, stable, advanced, and intelligent electric control system

Self-developed controller SYMC specially designed for engineering machinery is configured. CAN-bus full-digital network control technology with a complete set of sensors features stable control signal, simple harness, and high reliability. Timely feedback of data information can achieve the monitoring of the overall working status in real-time; the load moment limiter equipped with the comprehensive intelligent protection system is used with accuracy within 3% to provide a comprehensive logic and interlock control, thus ensuring more safe and reliable operation.

Superstructure

-  **Cab**
- It is made of safety glass and anti-corrosion steel plate with ergonomic design, such as full-coverage soften interior, huge space, panoramic sunroof, adjustable seats, air conditioner and electric window screen wiper etc., providing more comfortable and relaxing operation experience. The display of load moment limiter integrates main console and operation display system, which clearly show the data of all operating superstructure conditions for lifting operation.

-  **Hydraulic system**
- High-quality key hydraulic components such as main oil pump, rotary pump, main valve, winch motor, and balancing parts etc. are adopted to achieve stable and reliable operation of the hydraulic system. Superior operation performance is guaranteed by accurate parameter matching.
 - Through the adoption of load sensitive variable displacement piston pump, pump displacement can be adjusted in real-time, achieving high-precision flow control with no energy loss during operation.
 - Electric controlled main valve has flow compensation and load feedback control function, enabling stable and convenient control of single action and combined action under different operation conditions
 - Winch adopts the electronically controlled variable motor to ensure high operation efficiency. Max. single line speeds of main and auxiliary winches is up to 125m/min.
 - Slewing system is equipped with the integrated slewing buffer valve with free slipping function to ensure more stable starting and control of the slewing operation and excellent micro-mobility.
 - Hydraulic oil tank capacity: 686L.

-  **Control system**
- CAN-bus instrument: CAN-bus instrument with a combined intelligent control electrical system is used for easy reading of the traveling parameters at any time. The engine fault warning function is applied to ensure convenient and fast troubleshooting.
 - With fully security protection system, main and auxiliary winches are equipped with over-roll out limiter and height limiters to prevent over-rolling out and over-hoisting of steel rope, including tip-over and limit angle protection.
 - Load moment limiter: The adoption of high intelligent load moment limiter system can comprehensively protect lifting operation, ensuring accurate, stable and comfort operation.
 - The fault diagnosis system can detect superstructure electricity, hydraulic action, chassis (for major safety failure), engine and gearbox for fault to ensure reliable operation of the crane.

-  **Luffing system**
- Dead-weight luffing provides more stable luffing operation at low energy loss.
 - Luffing angle: -2°~ 80°.

-  **Telescopic system**
- Five-section boom is applied with basic boom length of 11.3m, full-extended boom length of 43.5m, jib length of 16m and lifting height of fully extended boom length of 43.7m respectively. Max. lifting height is 60m including jib. It is made of fine grain high-strength steel with U-shaped cross section and with telescopic operation controlled independent by dual- cylinder rope.

-  **Slewing system**
- 360° rotation can be achieved with Max. slewing speed of 2.0r/min. Electric controlled proportional speed adjustment is applied to provide stable and reliable operation of the system. Unique rotary buffer design ensures more stable braking.

Superstructure

-  **Hoisting system**
- The adoption of pump and motor double variable speed control ensures high efficiency and excellent energy saving functionality. With perfect combination of winch balance valve and unique anti-slip technology, heavy load can lift and lower smoothly. Closed winch brake and winch balance valve effectively prevent imbalance of the hook.
 - One main hook: 610Kg, one auxiliary hook: 90Kg, and the Max. lifting height are 60t and 5t. Wire rope of main winch: left-handed wire rope 18-35W×7-1960L220m. Wire rope of auxiliary winch: left-handed wire rope 18-35W×7-1960L130m.

-  **Safety system**
- Load moment limiter: Load moment limiter calculation system based on lifting load mechanical model is established using an analytical mechanics method with rated lifting accuracy up to ±3% through on-line non-load calibration, providing full protection to lifting operation. In case of overload operation, system will automatically issue an alarm to provide safety protection for manipulation.
 - Hydraulic system is configured with the balance valve, overflow valve and two-way hydraulic lock etc. components, thus achieving stable and reliable operation of the hydraulic system.
 - Main and auxiliary winches are equipped with over roll-out limiter to prevent over rolling-out of wire rope.
 - Boom and jib ends are equipped with height limiters respectively to prevent over-hoisting of wire rope.
 - Boom head is equipped with anemometer and press sensor to indicate the working condition of whole crane in real-time, giving an alarm and cutting off the dangerous action automatically.

-  **Counterweight**
- Counterweight is 4600kg, a flexible counterweight of 3000kg is optional.

Chassis

-  **Cab**
- Cab is made of new steel structure self-developed by SANY, featuring excellent shock absorption and tightness, which is configured with swing-out doors at both sides, pneumatically suspended driver's seat and passenger seat, adjustable steering wheel, large rearview mirror, comfort driver chair with a headrest, anti-fog fan, air conditioner, stereo radio, complete control instruments and meters, as well as optional configuration of sleeping berth, providing more comfortable, safe, and humanized operation experience.

-  **Carrier frame**
- Designed and manufactured by SANY, the brand new high strength carrier frame with extra height and width enhances anti-torsion behavior by 78% and bending resistance by 28%, comparing to groove structure. Rigidity and bearing capacity are improved significantly.

-  **Axles**
- Axles 3 and 4 are drive axles and axles 1 and 2 are steering axles. The use of welding process for axle housing provides stronger load bearing capacity.

-  **Engine**
- Type: Inline six-cylinder, water cooled, supercharged and inter-cooling diesel engine
 - Rated power: 250kw/2100r/min
 - Environment-protection: Emission complies with EuroIII standard
 - Capacity of fuel tank: 350L

Chassis

- Transmission system**
- Gearbox: Manual gearbox is adopted with 9-gear and large speed ratio range applied, which meets the requirements of low gradeability speed and high traveling speed.
 - Transmission shaft: With optimized arrangement of the transmission shaft, the transmission is stable and reliable. For most optimized transmission, face-tooth coupling transmission shaft is used with large transmission torque .
- Brakes system**
- Air servo brakes are used for all wheels with dual-circuit brake system applied, engine is equipped with an exhaust brake.
 - Brakes system includes traveling brake, parking brake, emergency brake and auxiliary brake.
 - Traveling brake: All wheels use the air servo brakes and dual-circuit brake system.
 - Parking brake: Force driven by accumulator is applied on the third to fourth axle.
 - For emergency brake, accumulator is used not only for cutting-off brake but also for emergency brake.
 - Auxiliary brake is exhaust brake with brake safety ensured while travelling downhill.
- Suspension system**
- Plate spring suspension system is adopted for axles 1 and 2, and rubber suspension is adopted for axles 3 and 4. Over 100,000 fatigue tests are conducted to ensure high strength and comfort ridding.
- Steering system**
- Hydraulic power mechanical steering systems are applied for axles 1 and 2 with unloading valve installed in the steering gear.
- Drive/Steer**
- 8 x 4
- Outriggers**
- Four-point supporting of the H-shaped outriggers ensures easy operation and strong stability with max. span up to 6m×7.2m. They are made of fine-grain high-strength steel sheet with horizontal single-cylinder rope line telescoping for first and second outriggers. Vertical cylinder of outrigger adopts bi-directional hydraulic locks to improve safety.
- Tyres**
- 12.00R20-20PR×12
- Electrical system**
- With 2*12V maintenance-free batteries, the crane power can be cut off manually via a mechanical master power switch. The use of CAN-bus control system can achieve information interaction between superstructure and undercarriage.

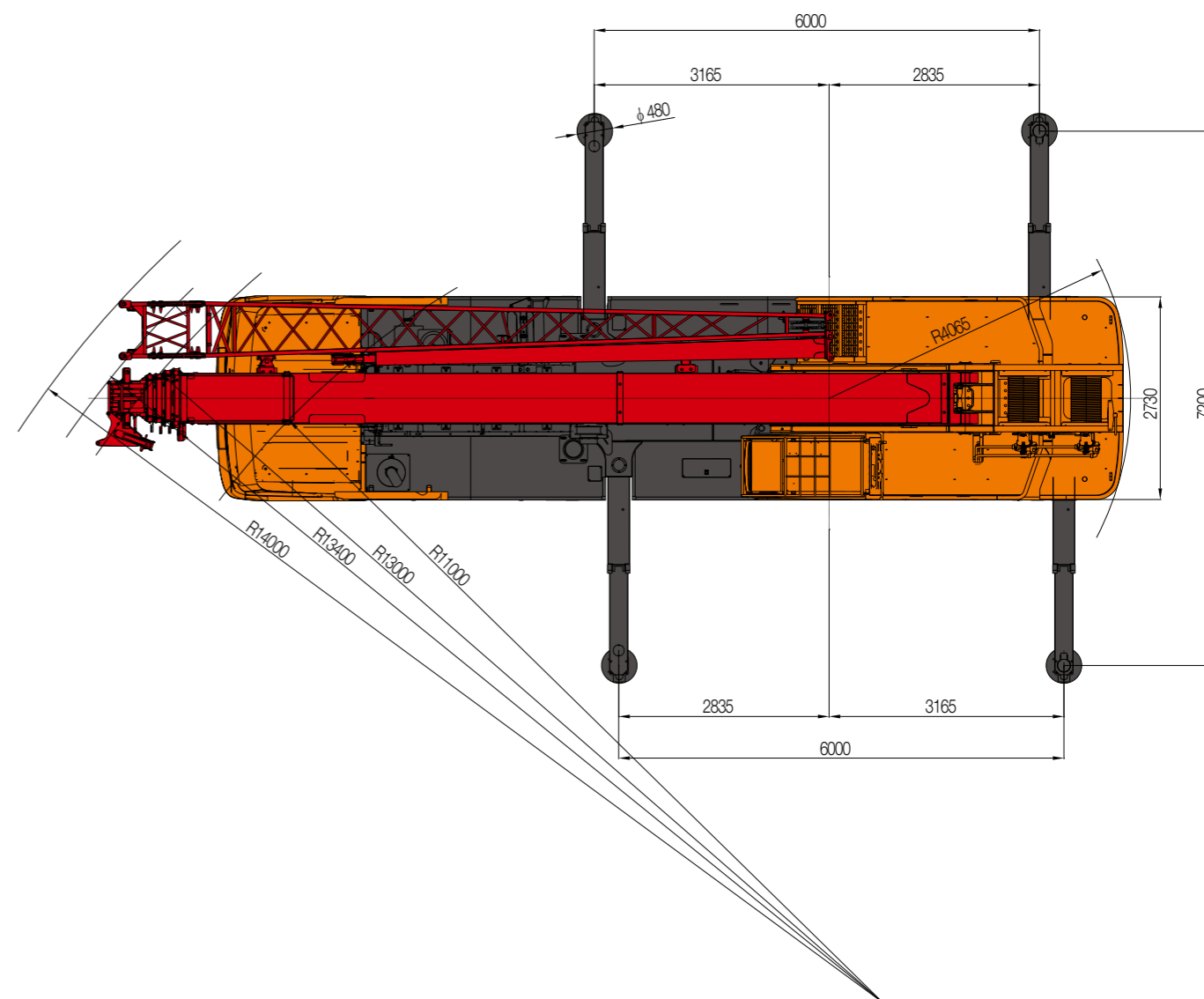
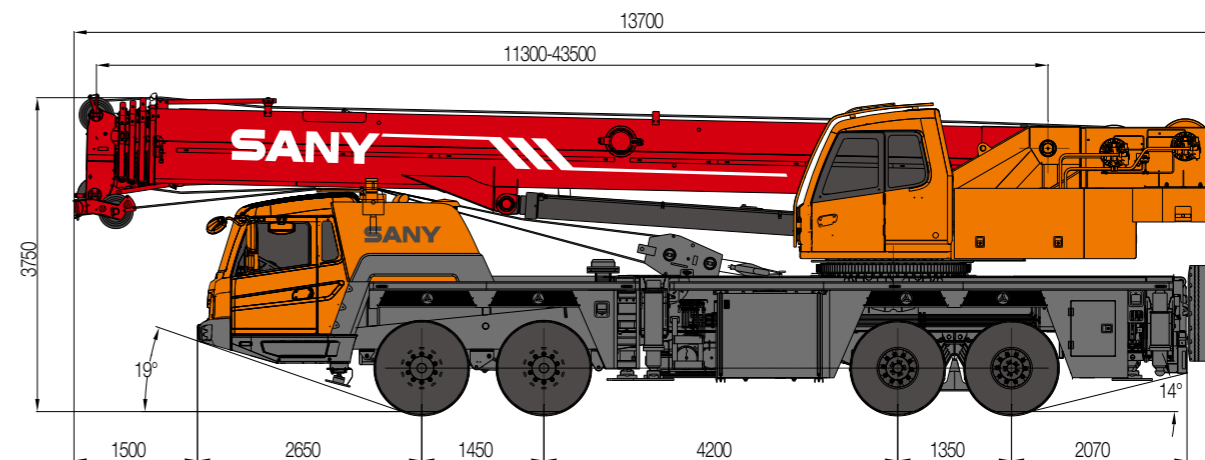

Type	Item	Parameter	
Capacity	Max. lifting capacity	60 t	
Dimensions	Overall length	13700 mm	
	Overall width	2750 mm	
	Overall height	3750 mm	
	Axle distance	Axle-1,2: 1450 mm Axle-2,3: 4200 mm Axle-3,4: 1350 mm	
Weight	Overall weight	42000 kg	
	Axle load	Axle load-1,2: 16000 kg Axle load-3,4: 26000 kg	
	Rated power	250 kW/ 2100 rpm	
	Rated torque	1425 N.m/ 1200-1500 rpm	
Traveling	Max.traveling speed	83 km/h	
	Turning radius	Min.turning radius: 11 m Min.turning radius of boom head: 14 m	
	Wheel formula	8 × 4	
	Min.ground clearance	295 mm	
	approach angle	19 °	
	Departure angle	14 °	
	Max.gradeability	42%	
	Fuel consumption per 100km	≤ 43 L	
Main Performance Data	Temperature range	- 20 ° ~ + 40 °	
	Min.rated range	3 m	
	Tail slewing radius of swingtable	4.065 m	
	Boom section	5	
	Boom shape	U-shaped	
	Max.lifting moment	Base boom	2009 kN·m
		Full-extend boom	1050.6 kN·m
		Full-extend boom+jib	521.1 kN·m
	Boom length	Base boom	11.3 m
		Full-extend boom	43.5 m
Full-extend boom+jib		59.5 m	
Outrigger span (Longitudinal×Transversal)	6 × 7.2 m		
Jib offset	0 °, 15 °, 30 °		
Working speed	Max.single rope lifting speed of main winch (no load)	125 m/min	
	Max.single rope lifting speed of auxiliary winch (no load)	125 m/min	
	Full extension/retraction time of boom	100 / 120 s	
	Full lifting/descending time of boom	60 / 80 s	
	Slewing speed	0~2.0 r/min	
Aircondition	Aircondition in up cab	Cooling	
	Aircondition in low cab	Heating/Cooling	

STC600S Working Ranges of Boom

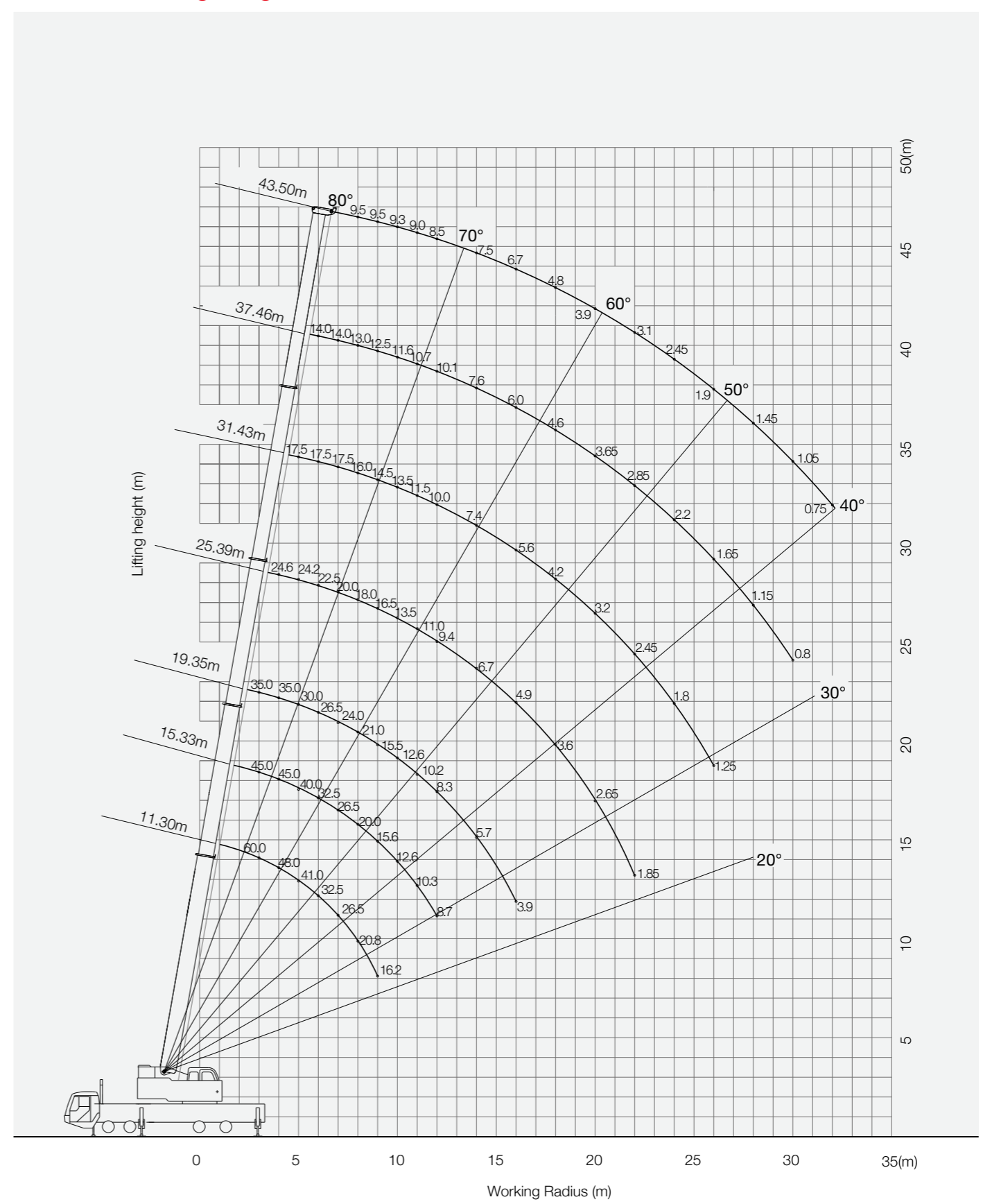

Unit:Kg

STC600S Boom Load Chart

Radius (m)	Outrigger extended, over side and rear (4.6T fixed counterweight)											Radius (m)
	11.3	15.33	17.34	19.35	23.38	25.39	29.41	31.43	35.45	37.46	43.5	
3.0	60000	45000	24600	35000								3.0
3.5	55000	45000	24600	35000	17500							3.5
4.0	48000	45000	24200	35000	17500	24600						4.0
4.5	45000	43000	24000	33000	17500	24600	14000					4.5
5.0	41000	40000	22500	30000	17500	24200	14000	17500				5.0
5.5	36000	36000	21000	28000	17500	24000	14000	17500	9500			5.5
6.0	32500	32500	20000	26500	16500	22500	13500	17500	9500	14000		6.0
6.5	29500	29500	19000	25000	16000	21000	12900	17500	9500	14000		6.5
7.0	26500	26500	18000	24000	15500	20000	12400	17500	9500	14000		7.0
7.5	23200	23500	17000	22000	15000	19000	11800	16700	9500	13500		7.5
8.0	20800	20000	16500	21000	14000	18000	11300	16000	9300	13000	9500	8.0
9.0	16200	15600	16000	15500	13000	16500	10500	14500	9000	12500	9500	9.0
10.0		12600	14600	12600	12500	13500	9600	13500	8500	11600	9300	10.0
11.0		10300	12100	10200	12000	11000	8900	11500	7800	10700	9000	11.0
12.0		8700	10200	8300	10600	9400	8300	10000	7300	10100	8500	12.0
14.0			7500	5700	8100	6700	7300	7400	6300	7600	7500	14.0
16.0				3900	6300	4900	6400	5600	5500	6000	6700	16.0
18.0					5000	3600	5300	4200	4700	4600	4800	18.0
20.0					4000	2650	4300	3200	4100	3650	3900	20.0
22.0						1850	3500	2450	3600	2850	3100	22.0
24.0							2800	1800	3050	2200	2450	24.0
26.0							2300	1250	2450	1650	1900	26.0
28.0									2050	1150	1450	28.0
30.0										1650	800	30.0
32.0											750	32.0
Telescoping Condition(%)												
Modes	I,II	I	II	I	II	I	II	I	II	I	I,II	Modes
2 section boom	0	50	0	100	0	100	0	100	0	100	100	2 section boom
3 section boom	0	0	25	0	50	25	75	50	100	75	100	3 section boom
4 section boom	0	0	25	0	50	25	75	50	100	75	100	4 section boom
5 section boom	0	0	25	0	50	25	75	50	100	75	100	5 section boom
Number of lines	12	10	6	8	4	6	4	4	3	4	3	Number of lines

Notes:

1. Values listed in the table refer to rated lifting capacity measured at flat and solid ground under the lever state of the crane;
2. Value above heavy line shall be determined by strength of the crane and under this line shall be determined by stability of the crane;
3. Working radius listed in the load chart is the actual radius with load;
4. Rated load values determined by stability shall comply with ISO 4305;
5. Rated lifting capacity listed in the table included weights of lifting hooks (610kg of main hook and 90kg of auxiliary hook)and hangers;
6. With the 5th outrigger extended, the value listed in the table shall be applicable for 360°operation;
7. Rated lifting capacity with pulley at boom tip shall not exceed 4000kg. If jib is applied, the rated lifting capacity of the boom shall be deducted by 2300kg.
8. If actual boom length and range are between two values specified in the table, larger value will determine the lifting capacity.

STC600S Working Ranges of Jib

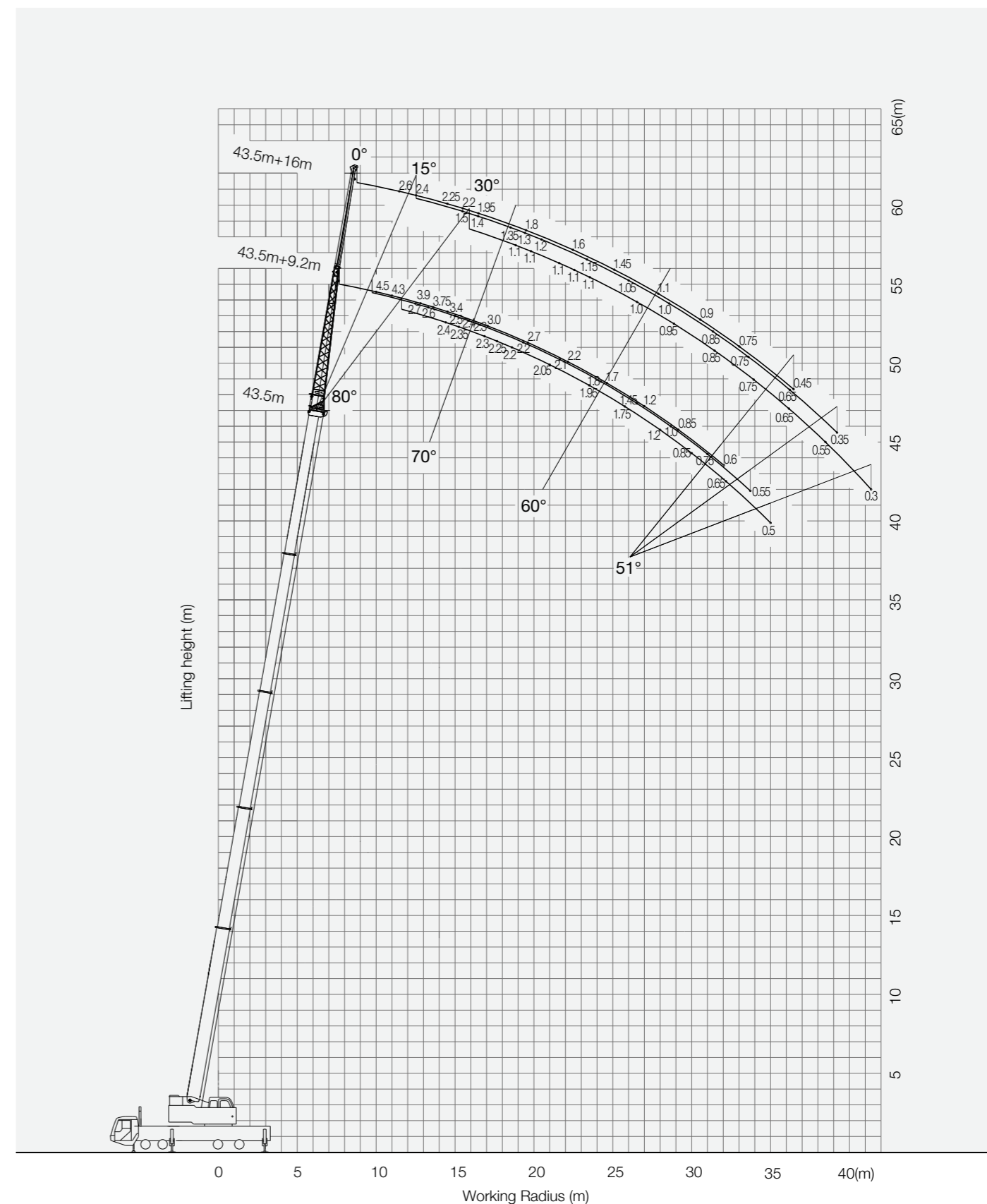

Unit:Kg

Full-extend outriggers, over side and rear,with max. span up to 6m×7.2m,counterweight of 4.6t,360°rotation















Main boom angle(°)	43.5+16m jib		
	0°	15°	30°
78°	2600	1500	1100
77°	2400	1400	1100
75°	2250	1350	1100
74°	2200	1300	1100
73°	1950	1200	1100
70°	1800	1150	1000
67°	1600	1050	950
64°	1450	1000	850
61°	1100	850	750
58°	900	750	650
55°	750	650	550
51°	450	350	300
Min.elevation angle		51°	

Unit:Kg

Full-extend outriggers, over side and rear,with max. span up to 6m×7.2m,counterweight of 4.6t,360°rotation

Main boom angle(°)	43+9.2m jib		
	0°	15°	30°
78°	4500	2700	2400
77°	4300	2600	2350
75°	3900	2500	2300
74°	3750	2400	2250
73°	3400	2300	2200
70°	3000	2200	2050
67°	2700	2100	1950
64°	2200	1800	1750
61°	1700	1450	1200
58°	1200	1000	850
55°	850	750	650
51°	600	550	500
Min.elevation angle		51°	

TRUCK CRANE

 STC200 Maximum Load Capacity: 20t Telescopic Boom: 4 Sections, 10.6-33m	 STC250 Maximum Load Capacity: 25t Telescopic Boom: 4 Sections, 10.65-33.5m	 STC250H Maximum Load Capacity: 25t Telescopic Boom: 5 Sections, 10.5-39.5m	 STC300TH Maximum Load Capacity: 30t Telescopic Boom: 4 Sections, 10.6-33.5m
 STC300H Maximum Load Capacity: 30t Telescopic Boom: 5 Sections, 10.5-39.5m	 STC500 Maximum Load Capacity: 50t Telescopic Boom: 5 Sections, 11.5-43m	 STC550 Maximum Load Capacity: 55t Telescopic Boom: 5 Sections, 11.5-43m	 STC550EYR Maximum Load Capacity: 55t Telescopic Boom: 5 Sections, 11.5-43m
 STC600 Maximum Load Capacity: 60t Telescopic Boom: 5 Sections, 11.5-43m	 STC750 Maximum Load Capacity: 75t Telescopic Boom: 5 Sections, 11.8-45m	 STC800 Maximum Load Capacity: 80t Telescopic Boom: 5 Sections, 11.8-45m	 STC800EYR Maximum Load Capacity: 80t Telescopic Boom: 5 Sections, 11.8-45m
 STC1000 Maximum Load Capacity: 100t Telescopic Boom: 5 Sections, 13.5-52m	 STC1000C Maximum Load Capacity: 100t Telescopic Boom: 6 Sections, 13.25-60m	 STC1300C Maximum Load Capacity: 130t Telescopic Boom: 6 Sections, 13.3-60m	

ALL TERRAIN CRANE

 SAC1800 Maximum Load Capacity: 180t Telescopic Boom: 6 Sections, 13.5-62m	 SAC2200 Maximum Load Capacity: 220t Telescopic Boom: 6 Sections, 13.5-62m	 SAC3000 Maximum Load Capacity: 300t Telescopic Boom: 7 Sections, 15.4-80m	 SAC3500 Maximum Load Capacity: 350t Telescopic Boom: 6 Sections, 15.2-70m
 SAC6000 Maximum Load Capacity: 600t Telescopic Boom: 7 Sections, 17.1-90m			

ROUGH-TERRAIN CRANE

 SRC350 Maximum Load Capacity: 35t Telescopic Boom: 4 Sections, 10-31.5m	 SRC550 Maximum Load Capacity: 55t Telescopic Boom: 4 Sections, 11.25-34.5m	 SRC550H Maximum Load Capacity: 55t Telescopic Boom: 5 Sections, 11.5-42.5m	 SRC750 Maximum Load Capacity: 75t Telescopic Boom: 5 Sections, 11.8-45m
--	---	---	--



Quality Changes the World

SANY AUTOMOBILE HOISTING MACHINERY

Address: SANY Industrial Park, Jinzhou Development Zone,
Changsha, Hunan, China.
Service Hotline: 4006098318
Email: crd@sany.com.cn
For more information, please visit: www.sanygroup.com

For our consistent improvement in technology, specifications may change without notice.
The machines illustrated may show optional equipment which can be supplied at additional cost.

Distributed By: